

Features and Benefits

- Operating voltage range from 2.2V to 18V
- Very high magnetic sensitivity
- CMOS technology
- Chopper-stabilized amplifier stage
- Low current consumption
- Open drain output
- SOT23 3L and flat TO-92 3L
both RoHS Compliant packages

Application Examples

- Automotive, Consumer and Industrial
- Solid-state switch
- Brushless DC motor commutation
- Speed detection
- Linear position detection
- Angular position detection
- Proximity detection

Ordering Information

Part No.	Temperature Code	Package Code
US4881	E (-40 °C to 85 °C)	SO (SOT23-3L)
US4881	E (-40 °C to 85 °C)	UA (TO-92)
US4881	K (-40 °C to 125 °C)	SO (SOT23-3L)
US4881	K (-40 °C to 125 °C)	UA (TO-92)
US4881	L (-40 °C to 150 °C)	SO (SOT23-3L)
US4881	L (-40 °C to 150 °C)	UA (TO-92)

1 Functional Diagram

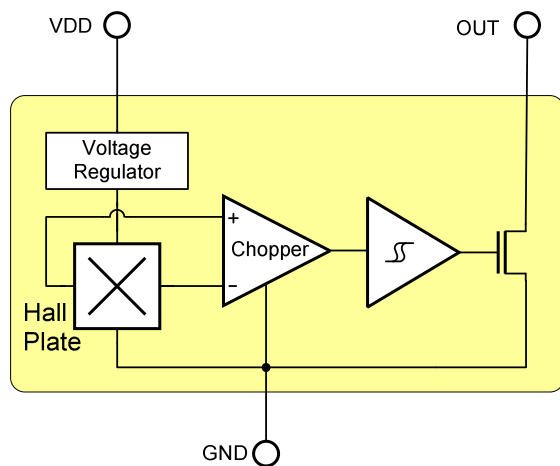

2 General Description

The Melexis US4881 is a bipolar Hall-effect switch designed in mixed signal CMOS technology.

The device integrates a voltage regulator, Hall sensor with dynamic offset cancellation system, Schmitt trigger and an open-drain output driver, all in a single package.

The low operating voltage and extended choice of temperature range make it suitable for use in automotive, industrial and consumer low voltage applications.

The devices are delivered in a Small Outline Transistor (SOT23) for surface mount process and in a Plastic Single In Line (TO-92 flat) for through-hole mount.

Both 3-lead packages are RoHS compliant.

如需订货请联系：天津越尔兴电子科技有限公司

电话022-88919721 传真：02258059049 网址：www.yearshine.com E-mail:sun@yearshine.com

Table of Contents

1 Functional Diagram	1
2 General Description.....	1
3 Glossary of Terms	3
4 Absolute Maximum Ratings.....	3
5 Pin Definitions and Descriptions.....	3
6 General Electrical Specifications	4
7 Magnetic Specifications	4
8 Output Behaviour versus Magnetic Pole	4
9 Detailed General Description.....	5
10 Unique Features.....	5
11 Performance Graphs	6
12 Application Information.....	7
12.1 Typical Three-Wire Application Circuit	7
12.2 Two-Wire Circuit	7
12.3 Automotive and Harsh, Noisy Environments Three-Wire Circuit	7
13 Application Comments.....	7
14 Standard information regarding manufacturability of Melexis products with different soldering processes.....	8
15 ESD Precautions.....	8
16 Package Information.....	9
16.1 SO Package (SOT23-3L).....	9
16.2 UA Package (TO-92 flat)	10
17 Disclaimer.....	11

3 Glossary of Terms

MilliTesla (mT), Gauss	Units of magnetic flux density: 1mT = 10 Gauss
RoHS	Restriction of Hazardous Substances
TSOT	Thin Small Outline Transistor (TSOT package) – also referred with the Melexis package code “SE”
ESD	Electro-Static Discharge
BLDC	Brush-Less Direct-Current

4 Absolute Maximum Ratings

Parameter	Symbol	Value	Units
Supply Voltage	V _{DD}	20	V
Supply Current	I _{DD}	50	mA
Output Voltage	V _{OUT}	20	V
Output Current	I _{OUT}	50	mA
Storage Temperature Range	T _S	-50 to 150	°C
Maximum Junction Temperature	T _J	165	°C
ESD Sensitivity (AEC Q100 002)	-	2.5	kV

Table 1: Absolute maximum ratings

Exceeding the absolute maximum ratings may cause permanent damage. Exposure to absolute-maximum-rated conditions for extended periods may affect device reliability.

Operating Temperature Range	Symbol	Value	Units
Temperature Suffix “E”	T _A	-40 to 85	°C
Temperature Suffix “K”	T _A	-40 to 125	°C
Temperature Suffix “L”	T _A	-40 to 150	°C

5 Pin Definitions and Descriptions

SE Pin №	UA Pin №	Name	Type	Function
1	1	VDD	Supply	Supply Voltage pin
2	3	OUT	Output	Open Drain Output pin
3	2	GND	Ground	Ground pin

Table 2: Pin definitions and descriptions

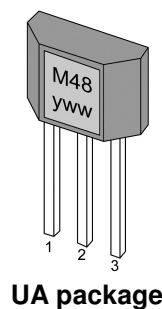
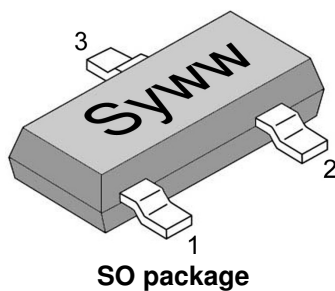

如需订货请联系：天津越尔兴电子科技有限公司

6 General Electrical Specifications

DC Operating Parameters $T_A = 25^\circ\text{C}$, $V_{DD} = 12\text{V}$ (unless otherwise specified)

Parameter	Symbol	Test Conditions	Min	Typ	Max	Units
Supply Voltage	V_{DD}	Operating	2.2		18	V
Supply Current	I_{DD}	$B < B_{RP}$	1.5		5	mA
Output Saturation Voltage	V_{DSon}	$I_{OUT} = 20\text{mA}$, $B > B_{OP}$			0.5	V
Output Leakage Current	I_{OFF}	$B < B_{RP}$, $V_{OUT} = 24\text{V}$		0.01	10	μA
Output Rise Time	t_r	$R_L = 1\text{k}\Omega$, $C_L = 20\text{pF}$		0.25		μs
Output Fall Time	t_f	$R_L = 1\text{k}\Omega$, $C_L = 20\text{pF}$		0.25		μs
Maximum Switching Frequency	F_{SW}			10		KHz
SO Package Thermal Resistance	R_{TH}			350		$^\circ\text{C/W}$
UA Package Thermal Resistance	R_{TH}			200		$^\circ\text{C/W}$

Table 3: Electrical specifications

7 Magnetic Specifications

DC Operating Parameters $T_A = 25^\circ\text{C}$, $V_{DD} = 12\text{V}$ (unless otherwise specified)

Parameter	Symbol	Test Conditions	Min	Typ	Max	Units
Operating Point	B_{OP}		-1		6	mT
Release Point	B_{RP}		-6		1	mT
Hysteresis	B_{HYST}		2		6	mT

Table 4: Magnetic specifications

Note 1: For typical values, please refer to the performance graphs in section 11

8 Output Behaviour versus Magnetic Pole

DC Operating Parameters $T_A = -40^\circ\text{C}$ to 150°C , $V_{DD} = 2.2\text{V}$ to 18V (unless otherwise specified)

Parameter	Test Conditions (SO)	OUT (SO)	Test Conditions (UA)	OUT (UA)
South pole	$B < B_{RP}$	High	$B > B_{OP}$	Low
North pole	$B > B_{OP}$	Low	$B < B_{RP}$	High

Table 5: Output behaviour versus magnetic pole

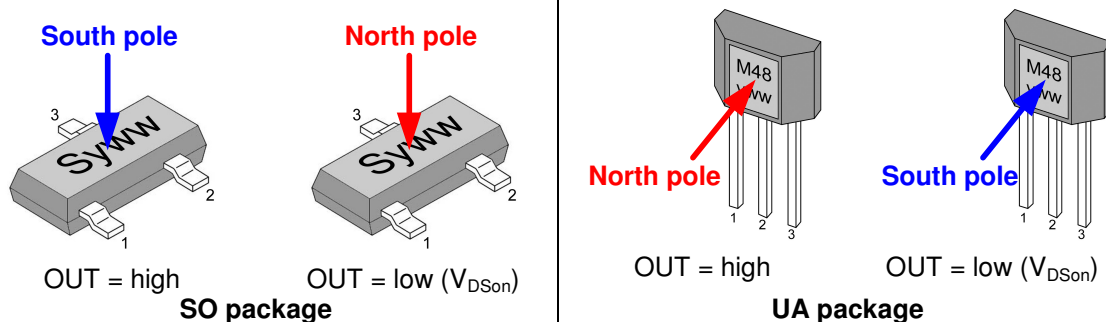

9 Detailed General Description

Based on mixed signal CMOS technology, Melexis US4881 is a Hall-effect device with very high magnetic sensitivity. It allows using generic magnets, weak magnets or larger air gap.

The chopper-stabilized amplifier uses switched capacitor techniques to suppress the offset generally observed with Hall sensors and amplifiers. The CMOS technology makes this advanced technique possible and contributes to smaller chip size and lower current consumption than bipolar technology. The small chip size is also an important factor to minimize the effect of physical stress. This combination results in more stable magnetic characteristics and enables faster and more precise design.

The operating voltage from 2.2V to 18V, low current consumption and large choice of operating temperature range according to "L", "K" and "E" specification make this device suitable for automotive, industrial and consumer low voltage applications.

The output signal is open-drain type. Such output allows simple connectivity with TTL or CMOS logic by using a pull-up resistor tied between a pull-up voltage and the device output.

10 Unique Features

The US4881 exhibits bipolar magnetic switching characteristics. Therefore, it operates with both south and north poles.

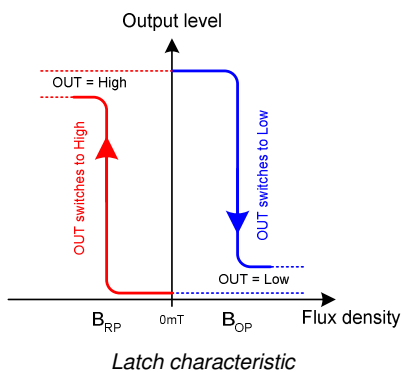

Typically, the device behaves as a latch with symmetric operating and release switching points ($B_{OP} = |B_{RP}|$). This means magnetic fields with equivalent strength and opposite direction drive the output high and low.

Removing the magnetic field ($B \rightarrow 0$) keeps the output in its previous state. This latching property defines the device as a magnetic memory.

Depending on the magnetic switching points, the device may also behave as a unipolar positive switch (B_{OP} and B_{RP} strictly positive) or negative switch (B_{OP} and B_{RP} strictly negative). That is the output can be set high and low by only using one magnetic pole. In such case, removing the magnetic field changes the output level.

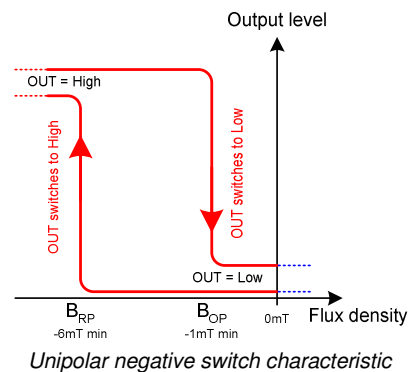
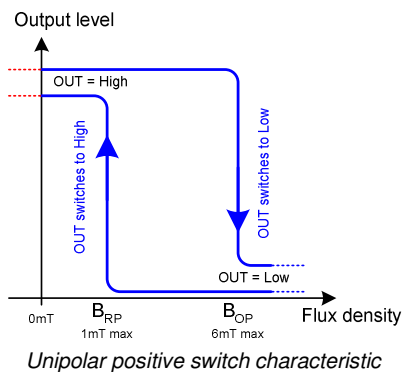

In latch, positive or negative switch behaviour, a magnetic hysteresis B_{HYST} keeps B_{OP} and B_{RP} separated by a minimal value. This hysteresis prevents output oscillation near the switching point.

11 Performance Graphs

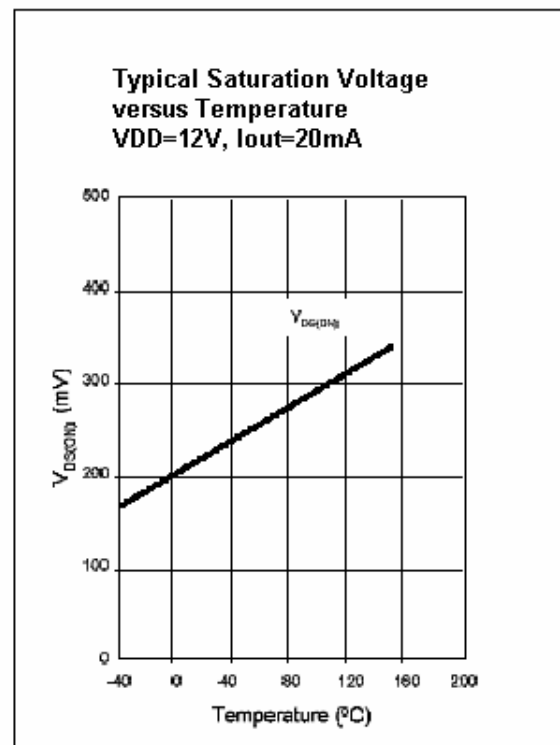
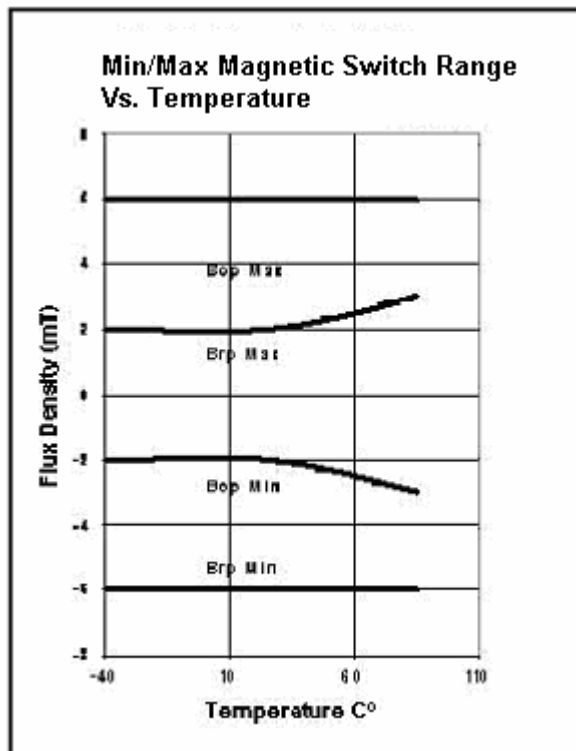
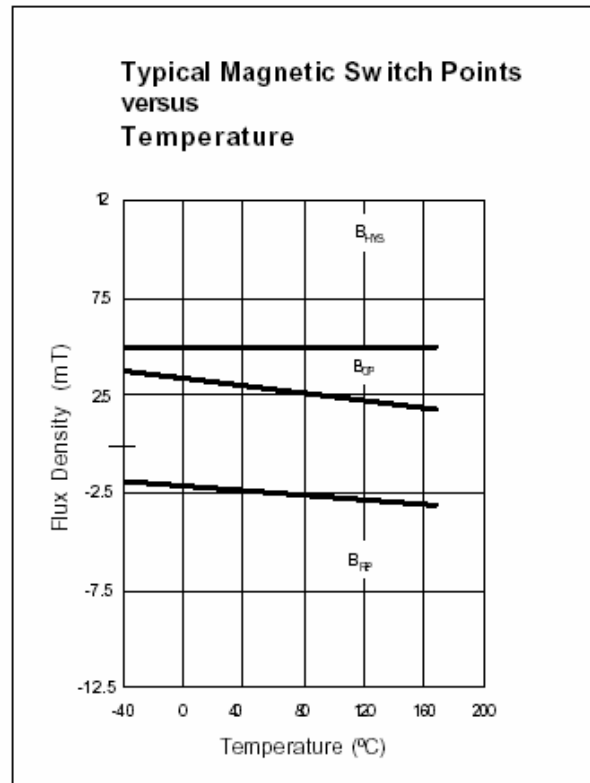
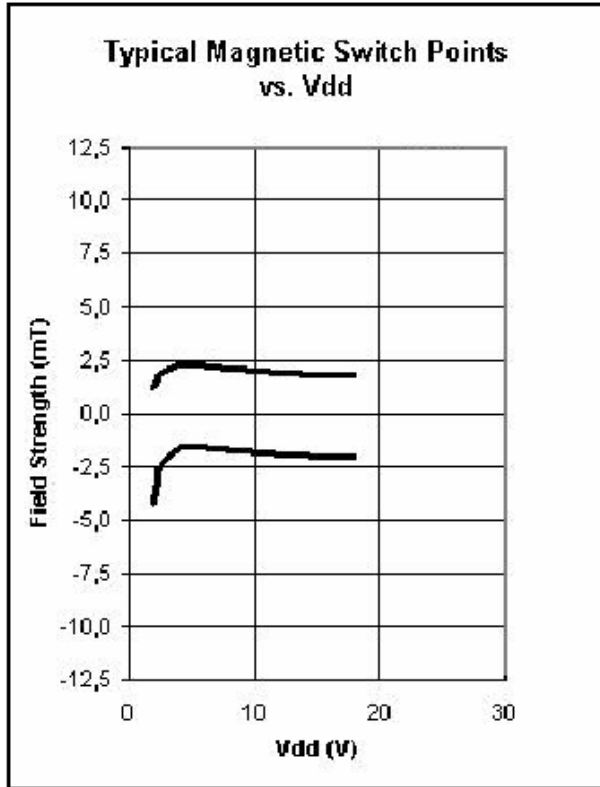

12 Application Information

12.1 Typical Three-Wire Application Circuit

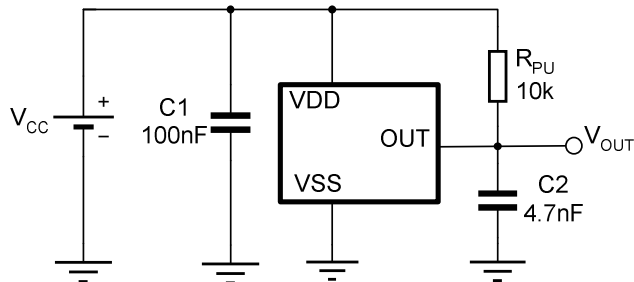

12.2 Two-Wire Circuit

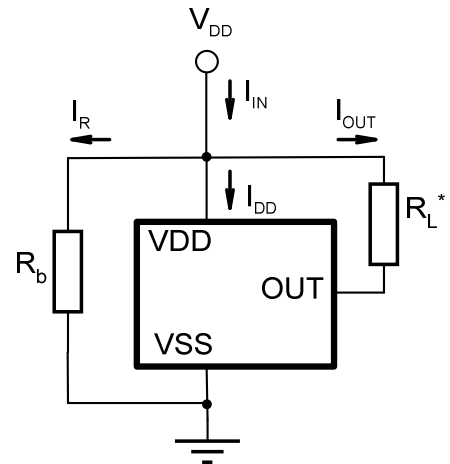

Note:

With this circuit, precise ON and OFF currents can be detected using only two connecting wires.

The resistors R_L and R_b can be used to bias the input current. Refer to the part specifications for limiting values.

$$B_{RP} : I_{OFF} = I_R + I_{DD} = V_{DD}/R_b + I_{DD}$$

$$B_{OP} : I_{ON} = I_{OFF} + I_{OUT} = I_{OFF} + V_{DD}/R_L$$

12.3 Automotive and Harsh, Noisy Environments Three-Wire Circuit

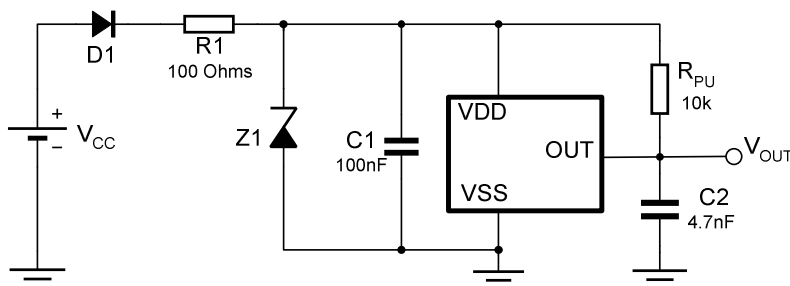

13 Application Comments

For proper operation, a 100nF bypass capacitor should be placed as close as possible to the device between the V_{DD} and ground pin.

For reverse voltage protection, it is recommended to connect a resistor or a diode in series with the V_{DD} pin. When using a resistor, three points are important:

- the resistor has to limit the reverse current to 50mA maximum ($V_{CC} / R1 \leq 50mA$)
- the resulting device supply voltage V_{DD} has to be higher than V_{DD} min ($V_{DD} = V_{CC} - R1 \cdot I_{DD}$)
- the resistor has to withstand the power dissipated in reverse voltage condition ($P_D = V_{CC}^2 / R1$)

When using a diode, a reverse current cannot flow and the voltage drop is almost constant ($\approx 0.7V$).

Therefore, a 100 Ω /0.25W resistor for 5V application and a diode for higher supply voltage are recommended. Both solutions provide the required reverse voltage protection.

When a weak power supply is used or when the device is intended to be used in noisy environment, it is recommended that figure 13.3 from the Application Information section is used.

The low-pass filter formed by $R1$ and $C1$ and the zener diode $Z1$ bypass the disturbances or voltage spikes occurring on the device supply voltage V_{DD} . The diode $D1$ provides additional reverse voltage protection.

14 Standard information regarding manufacturability of Melexis products with different soldering processes

Our products are classified and qualified regarding soldering technology, solderability and moisture sensitivity level according to following test methods:

Reflow Soldering SMD's (Surface Mount Devices)

- IPC/JEDEC J-STD-020
Moisture/Reflow Sensitivity Classification for Nonhermetic Solid State Surface Mount Devices (classification reflow profiles according to table 5-2)
- EIA/JEDEC JESD22-A113
Preconditioning of Nonhermetic Surface Mount Devices Prior to Reliability Testing (reflow profiles according to table 2)

Wave Soldering SMD's (Surface Mount Devices) and THD's (Through Hole Devices)

- EN60749-20
Resistance of plastic- encapsulated SMD's to combined effect of moisture and soldering heat
- EIA/JEDEC JESD22-B106 and EN60749-15
Resistance to soldering temperature for through-hole mounted devices

Iron Soldering THD's (Through Hole Devices)

- EN60749-15
Resistance to soldering temperature for through-hole mounted devices

Solderability SMD's (Surface Mount Devices) and THD's (Through Hole Devices)

- EIA/JEDEC JESD22-B102 and EN60749-21
Solderability

For all soldering technologies deviating from above mentioned standard conditions (regarding peak temperature, temperature gradient, temperature profile etc) additional classification and qualification tests have to be agreed upon with Melexis.

The application of Wave Soldering for SMD's is allowed only after consulting Melexis regarding assurance of adhesive strength between device and board.

Melexis is contributing to global environmental conservation by promoting **lead free** solutions. For more information on qualifications of **RoHS** compliant products (RoHS = European directive on the Restriction Of the use of certain Hazardous Substances) please visit the quality page on our website:

<http://www.melexis.com/quality.asp>

15 ESD Precautions

Electronic semiconductor products are sensitive to Electro Static Discharge (ESD). Always observe Electro Static Discharge control procedures whenever handling semiconductor products.

16 Package Information

16.1 SO Package (SOT23-3L)

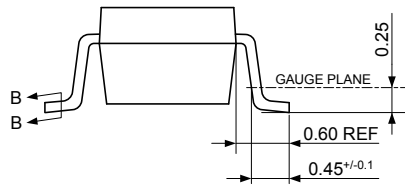
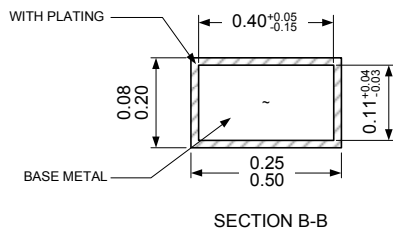
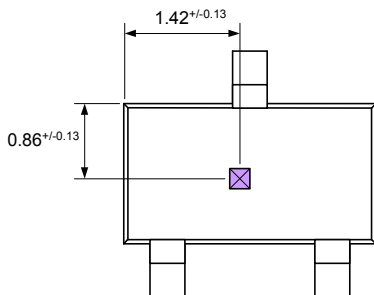
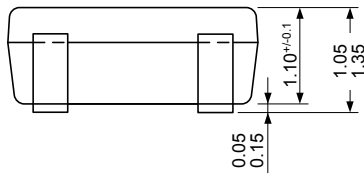
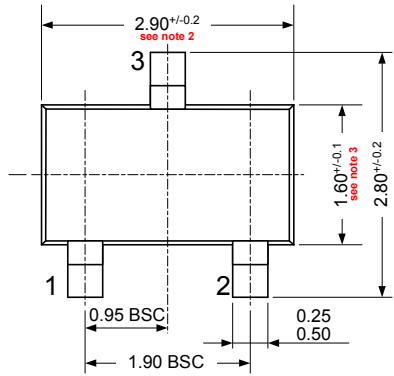

Notes:

1. All dimensions are in millimeters
2. Mold flash, protrusions or gate burrs not included.
Mold flash, protrusions or gate burrs shall not exceed 0.10mm per side.
3. Interlead flash or protrusion not included.
Interlead flash or protrusion shall not exceed 0.10mm per side.
4. The package top may be smaller than the package bottom.

Marking:

Top side : Syww S = part number (US4881)
 y = year
 ww = calendar week

Hall plate location

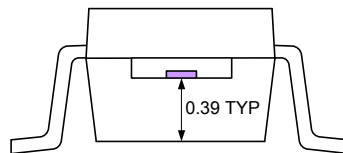

16.2 UA Package (TO-92 flat)

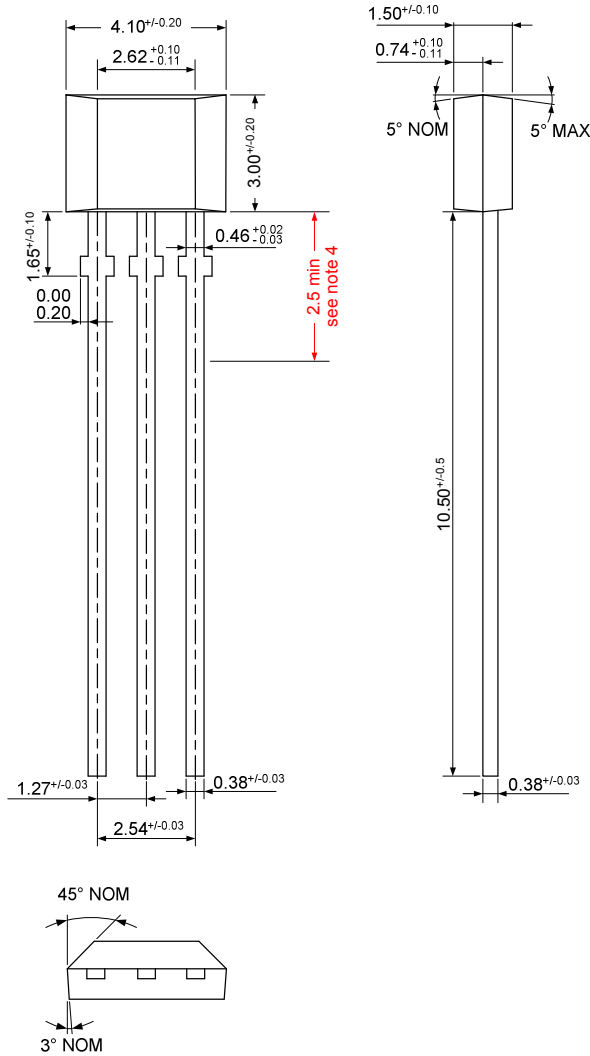

Notes:

1. All dimensions are in millimeters
2. Package dimension exclusive molding flash.
3. The end flash shall not exceed 0.127 mm on each side.
4. To preserve reliability, it is recommended to have total lead length equal to 2.5mm minimum, measured from the package line.

Marking:

- 1st Line : M48 - Part number (US4881)
 2nd Line : yww
 y - last digit of year
 ww - calendar week

Hall plate location

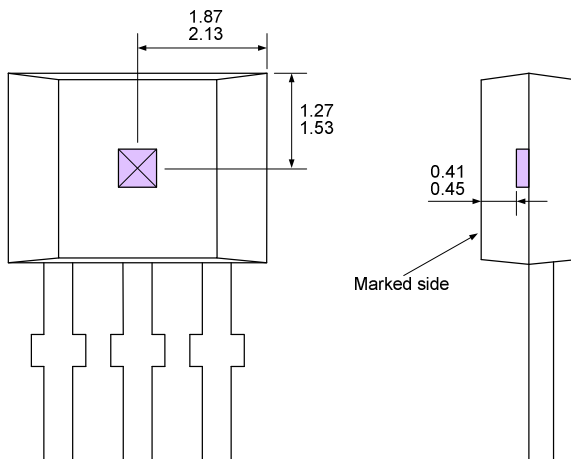

Notes:

1. All dimensions are in millimeters

17 Disclaimer

Devices sold by Melexis are covered by the warranty and patent indemnification provisions appearing in its Term of Sale. Melexis makes no warranty, express, statutory, implied, or by description regarding the information set forth herein or regarding the freedom of the described devices from patent infringement. Melexis reserves the right to change specifications and prices at any time and without notice. Therefore, prior to designing this product into a system, it is necessary to check with Melexis for current information. This product is intended for use in normal commercial applications. Applications requiring extended temperature range, unusual environmental requirements, or high reliability applications, such as military, medical life-support or life-sustaining equipment are specifically not recommended without additional processing by Melexis for each application.

The information furnished by Melexis is believed to be correct and accurate. However, Melexis shall not be liable to recipient or any third party for any damages, including but not limited to personal injury, property damage, loss of profits, loss of use, interrupt of business or indirect, special incidental or consequential damages, of any kind, in connection with or arising out of the furnishing, performance or use of the technical data herein. No obligation or liability to recipient or any third party shall arise or flow out of Melexis' rendering of technical or other services.

© 2005 Melexis NV. All rights reserved.

For the latest version of this document, go to our website at
www.melexis.com

Or for additional information contact Melexis Direct:

Europe, Africa, Asia:
Phone: +32 1367 0495
E-mail: sales_europe@melexis.com

America:
Phone: +1 603 223 2362
E-mail: sales_usa@melexis.com

ISO/TS 16949 and ISO14001 Certified